

REVISIONS			
LTR		DATE	APPROVED
A	INITIAL RELEASE	5/5/03	

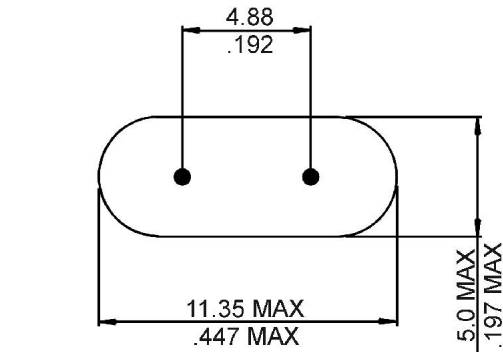
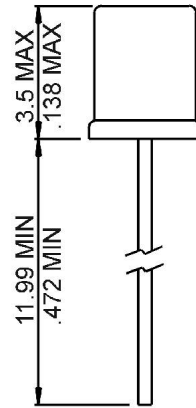
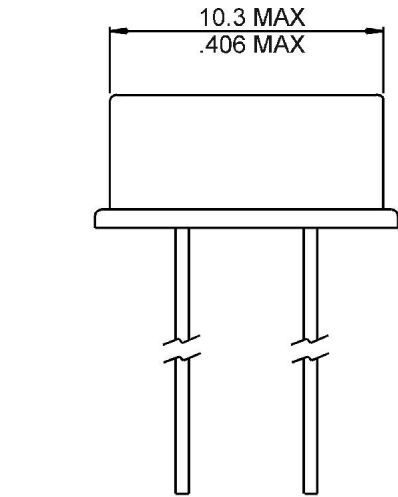

SPECIFICATIONS:

NOMINAL FREQUENCY:	12.288 MHz
MODE OF OSCILLATION:	FUNDAMENTAL
FREQUENCY TOLERANCE AT 25°C:	±30 PPM MAX
FREQUENCY STABILITY OVER TEMPERATURE RANGE:	±50 PPM MAX
OPERATING TEMPERATURE RANGE:	-20°C TO +70°C
STORAGE TEMPERATURE RANGE:	-55°C TO +125°C
AGING:	±5 PPM PER YEAR MAX
LOAD CAPACITANCE:	20 pF
DRIVE LEVEL:	100 µW TYP, 1000 µW MAX
SHUNT CAPACITANCE:	7 pF MAX
EQUIVALENT SERIES RESISTANCE:	60 OHMS MAX
HOLDER TYPE:	HC-49/S AS SHOWN

RALTRON

10651 NW 19TH STREET
MIAMI, FL 33172

ALL DIMENSIONS ARE IN mm/inch
UNLESS OTHERWISE SPECIFIED

DRAWN BY: Part Generator

CHECKED BY:

APPROVED BY:

SCALE: SHEET 1 OF DATE:

CAGE CODE:

Ø VUE Ø

DRAWING TITLE:

**LOW PROFILE MICROPROCESSOR
CRYSTAL**

DRAWING NUMBER:

AS-12.288-20